

COMPONENTS	
1. post	15. pin
2. main arm	16. rubber loop
3. tube	17. pin hole
4. side plate	18. handle
5. long arm	19. safety clamp
6. short arm <small>*not for octagonal umbrella</small>	20. winch
7. support arm	21. locking mechanism
8. hat arm	22. bolt-down
9. conduit (insert spring & nylon)	23. in-ground
10. rubber strap	24. inner revolving
11. main canopy	25. outer revolving
12. top canopy	26. spigot
13. central column	27. lower bolt
14. button	28. bearing

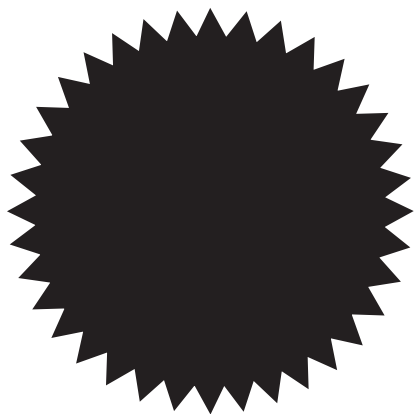

LIFESTYLE OUTDOOR UMBRELLAS
 Email: admin@tropiccover.com Web Site: www.tropiccover.com
 Phone: 1800 678 040 Fax: 61 - 7 3875 1017
 Factory: Unit 2, 38 Gladstone Street, Moorooka, Brisbane 4105
 Postal: PO Box 571 Main Beach, Gold Coast, Qld 4217 Australia

5 Year Warranty & Umbrella Instructions

Congratulations on purchasing a tropiccover umbrella.
 Please read these instructions carefully and retain technical information

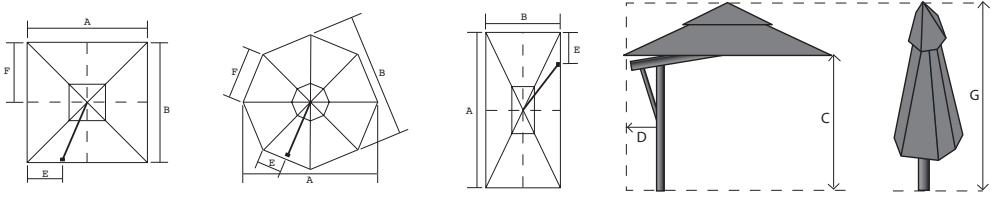
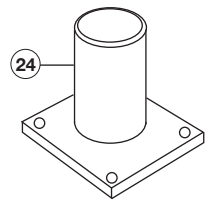
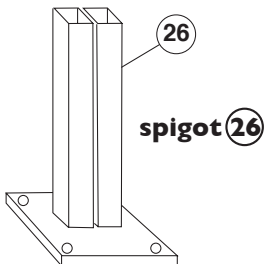
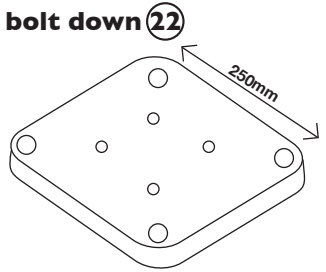
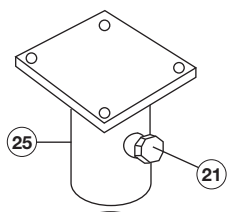
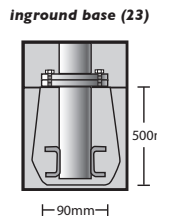
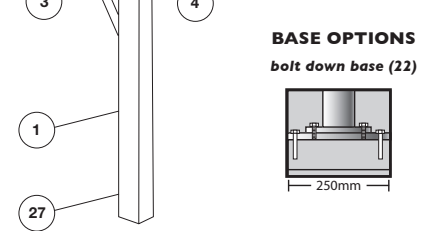
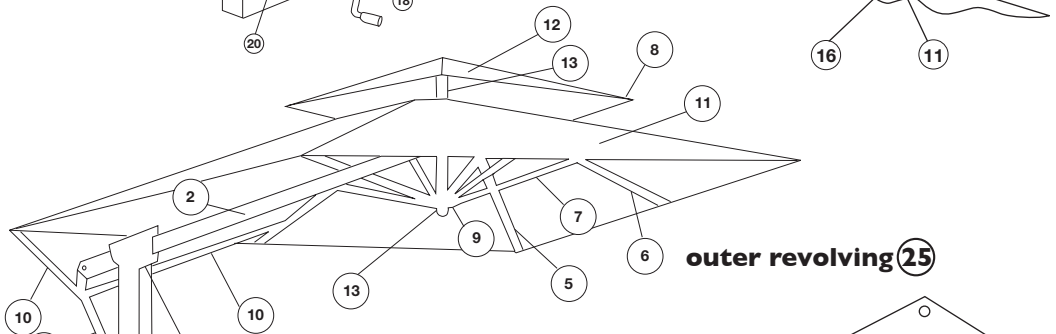
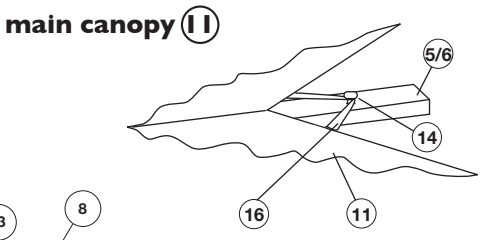
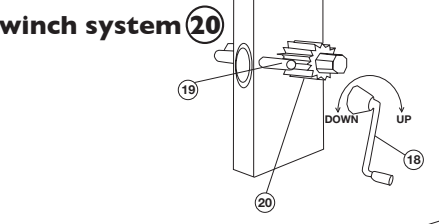
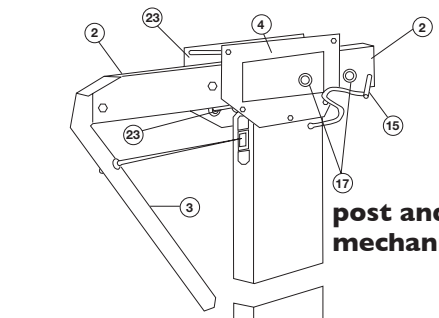

TROPICCOVER - MODELS, SHAPES AND SIZES - all measurements are approximate in mm

MODEL	SHAPE	A	B	C	D	E	F	G	AREA
S30	Square	3000	3000	2450	0	900	1500	3100	9.50 sq m
S35	Square	3500	3500	2400	250	1200	1750	3100	12.25 sq m
S40	Square	4000	4000	2450	450	1350	2000	3250	16.00 sq m
D35	Octagonal	3500	3200	2550	0	650	1320	3100	8.65 sq m
D40	Octagonal	4000	3600	2500	200	750	1500	3100	11.50 sq m
D45	Octagonal	4500	4200	2450	500	850	1700	3100	14.30 sq m
D50	Octagonal	5000	4600	2400	700	900	1875	3100	17.40 sq m
R55	Rectangular	3700	1500	2600	+250	900	1850/1500	3100	5.50 sq m
R60	Rectangular	4100	1700	2550	+200	1200	2050/1700	3100	7.00 sq m
R70	Rectangular	4000	3000	2450	0	1350	2000/1500	3100	12.00 sq m



5 YEAR WARRANTY

Please complete data below and retain for your convenience.

model no. _____ purchase date _____

base type _____ Tropicover no. _____

purchased from _____

Tropicover Warrants that the umbrellas supplied by it to be free from defects in material and workmanship for Five (5) Years from the date of purchase.

Tropicover has been designed to provide long at satisfactory service and protection, when operated in accordance with the instructions and under normal use. All Tropicover components are checked prior to dispatch. If installation is not carried out by Tropicover Agent/Dealer the purchaser is required to inspect all parts carefully on receipt of the product. Should any part be missing or prove defective, please notify your Agent/Dealer prior to installation.

CONDITIONS OF WARRANTY

1. This warranty does not cover any repairs consequent upon accident, alterations or repairs by any other than an authorised Agent/Dealer of Tropicover, misuse, fire, floods, earthquakes or excessively high wind conditions.
2. This warranty applies to the original purchaser only, who is required to ensure that the data above is completed and retained.
3. This warranty is valid only for installation made by a Tropicover Agent/Dealer if you install the Tropicover yourself the installation must be carried out exactly as shown in the Tropicover assembly Instructions.

TROPICOVER WARRANTY

The benefits given by this warranty are in addition to all other rights and remedies in respect of the product which the purchaser has under the Trade Practices Act and similar State and Territory laws. Nothing in this warranty will exclude, restrict or modify any condition, warranty, right or liability implied in this purchase or is protected by law, where to do so would render this warranty void.

4. Owner to ascertain position of all underground pipes and electrical wires and notify installer of any obstacles. Although all care will be taken, no responsibility can be accepted for any under ground breakages.
5. This warranty is valid only if both pin and side strap which are supplied with the Tropicover are in place at all times the Tropicover is erected.
6. This warranty is valid only if the fabric has been kept free of dust and grit by regular hosing as this will help prolong the life of the fabric.
7. This warranty valid only if the Tropicover is put up and collapsed as detailed in the Assembly Instructions.
8. If the Tropicover has to be transported for repairs, both canopies must be removed from the frame prior to transportation and both canopy and frame must be wrapped separately to avoid damage during transit.
9. The cost of transportation and insurance both ways for any repair of the Tropicover is to be paid by the claimant.
10. This warranty is the only express warranty given by Tropicover. No person has the authority to change or add to these obligations and liabilities.
11. Tropicover Pty Ltd reserves the right to determine whether or not fault is caused by faulty workmanship or material or any other part is defective.
12. Tropicover may offer advice but accepts no responsibility as to the suitability of the ultimate position of the Tropicover.

To meet warranty conditions and to maximise the life span of your umbrella. Please read these instructions prior to installation.

TROPICOVER UMBRELLA INSTRUCTIONS

- A BOLT DOWN BASE (22)** - is suited for mounting on an existing concrete slab. NB. a minimum depth of 100mm with steel mesh reinforcing and minimum slab size of 3 metres x 3 metres. Locate the plate in required position - mark the four holes and drill to required depth in accordance with the size of suitable concrete anchor bolts 16od/12id 70 or 100mm long or dyna bolt 12 or 16od 70 or 100mm long. If in any doubt - use an Inground Base (23).
- AI ON TIMBER DECK (22)** - use a professional tradesman to secure the plate (22) with four long bolts and nuts into the floor beams and into the two bracing timber beams.
- B INGROUND BASE (23)** - the installation should be carried out as in the diagram over leaf - to be concrete with flange coupling level with concrete surface or paving (hole size should be 500mm depth x angle to 400mm wide). Please use pre-mixed concrete or pre-mix rapid mix concrete.
- C INNER REVOLVING BASE (24)** - is attached to the bolt down plate (22) or the in-ground base (23).
- D SPIGOT (26)** - The spigot (26) is attached to the outer revolving (25) locking mechanism must be facing outside of the post (1) the post (1) must be vertical to the ground, if not - fit washes under plate (22) or revolving inner (24).
- E UMBRELLA POST (1)** - make sure that the spring and the nylon are inside the conduit (9). The post (1) is to be secured to the spigot (26) by locking the lower bolt (27) onto the spigot (26) to enable you to open and close the umbrella freely, the umbrella must be installed at no less than 800mm from any wall or fence.
- F MAIN CANOPY (11)** - remove the canopy from the bag and lower the open centre hole of the canopy over the top of the frame making sure that the arms pockets are facing down. (This should be done using a free standing ladder beside the Tropicover frame). Attach the rubber loop (16) at the centre hole of the canopy to each of the buttons (14) and continue this procedure in order until all are attached. Insert each arm (5), (6) into the appropriate pocket in direct line with the rubber loop (16) - proceeding around the umbrella until all eight arms (5), (6) are secured. N.B. make sure on square and rectangular umbrella that the canopy is correctly located for long (5) and short (6) arms eg. long arms are corner arms.
- G TOP CANOPY (12)** - remove the screws from the winch handle (18) - attach each screw-screwing it to the bottom corner of each hat arm (8). Place the canopy (12) and push into top of each screw of the hat arm (8) - repeating this around the canopy.
- H TO ERECT THE TROPICOVER UMBRELLA** - Wind the winch (20) using the handle (18) in a clockwise direction - ensuring that the safety clamp (19) beside the winch (20) is on at all times, when the umbrella is being put up make sure there are no obstacles in the way. If the umbrella does not go up - **check out the problem.** Continue winding until the side plates (4) passes the first hole (17) insert the pin (15) into the pin hole (17). If the canopy becomes loose insert pin (15) to the second hole (17) - then release the safety clamp (19) from the winch (20) - winding the winch (20) counter clock wise until the pin (15) touches the side plates (4). Return the safety clamp (19) to winch (20), (now the weight of the umbrella is on the pin (15), not the cable). To wind down the Tropicover umbrella use your handle (18) turning clockwise to release the pin (15) - pull out the pin (15) - lift out the safety clamp (19) and slowly wind counter clockwise and pull tube (3) down until the umbrella is closed.
- I SECURE THE SIDE STRAPS (10)** - evenly tie to each arm (5), (6) beside the tube (3). This will eliminate the movement of the umbrella in windy conditions. Do not pull the side straps (10).
- J TO REVOLVE THE UMBRELLA** - loosen the locking mechanism (21) using the winch handle (18) and turn the umbrella to the new position then lock the locking mechanism (21).
- K KEEP DUST AND GRIT OUT OF THE CANOPIES** - (11), (12) by periodically hosing them. This will maximise the life of the fabric.
- L WHEN THE TROPICOVER UMBRELLA IS DOWN** - ensure that all folds of the canopy are pulled out and folded the same direction eg. all either clockwise. Use the long strap supplied with your Tropicover umbrella to tie around the medium to lower area of the main canopy (11) - this will prevent damage to the canopy (11).
- M IF YOU TRANSPORT YOUR TROPICOVER UMBRELLA** - (eg. to a new residence or for a warranty claim or a repair) - the canopies (11), (12) must be removed, folded and transported separately to the frame to avoid damage.

PLEASE NOTE

The post of your Tropicover umbrella must be totally vertical (90°) in order for the canopies (11), (12) to sit horizontally. The post (1) can be shortened to suit (maximum cut off 200mm). The angle of the Tropicover canopies can be adjusted slightly by winding the adjuster located at the lower half of the central column (13). (The adjuster can be wound only when the umbrella is closed). It is vital that your umbrella is put up and down as required so that you do not incur repair costs for situations that are not covered by your warranty eg. Tropicover umbrella left up in excessively strong winds. If it is permanently erected, it will at some stage be subjected to conditions for which your umbrella has not been designed to withstand and may be damaged. Always remember the maximum life span of your umbrella will only be obtained if it is treated at all times as an umbrella and not as permanent structure.

Should you have any problems with our Tropicover umbrella. Contact Tropicover freecall:

1800 678 040